

Article number: 021816011098

Description: Clamp with bracket and rubber
SPGU 6011. 98/30 SK

Measures

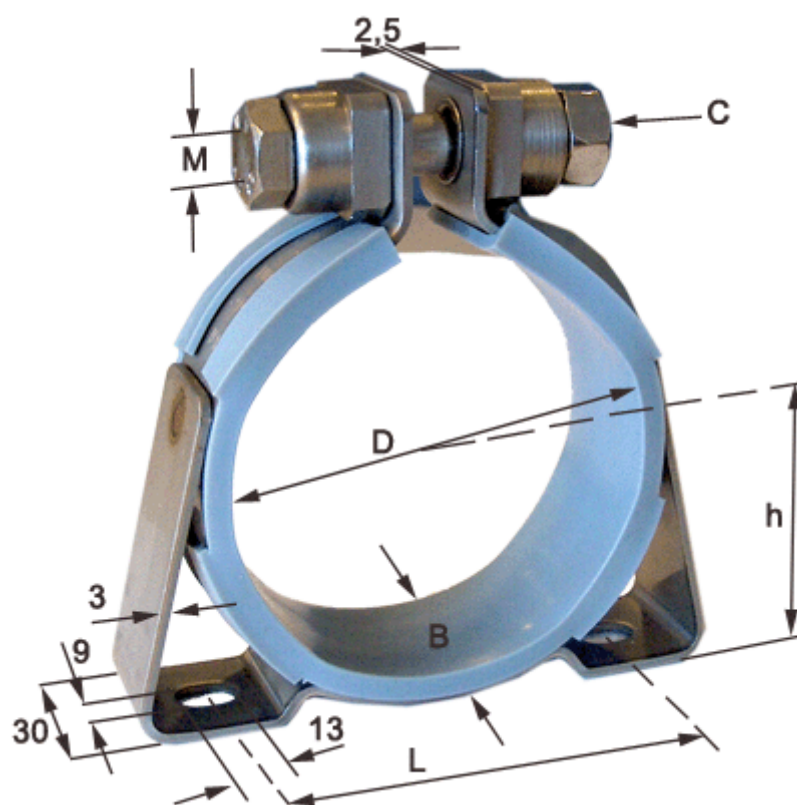

C (screw type) = SK hexagon screw

Diameter D = 98

h = 58

L = 90

Width B = 30